

S6

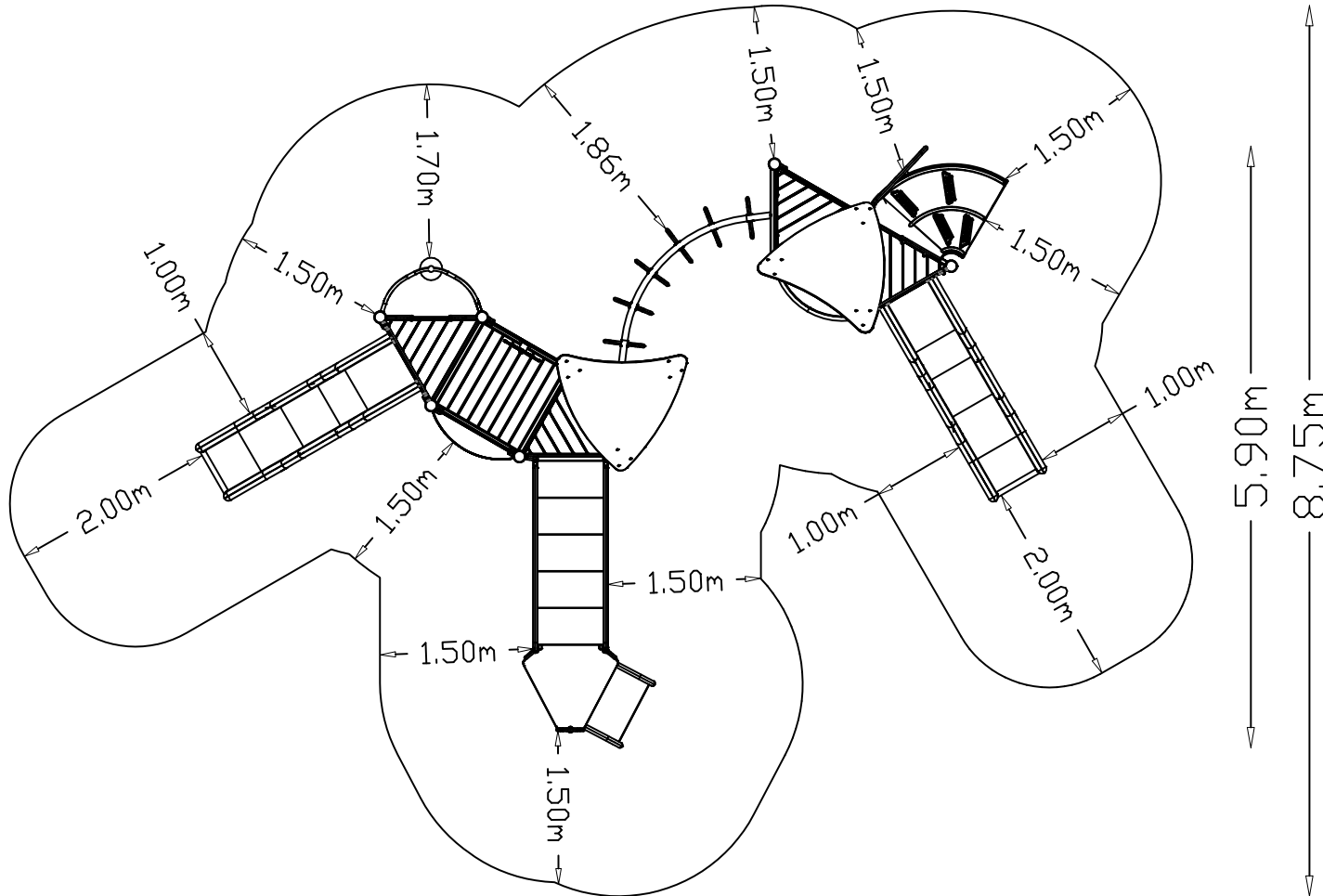

EN1176
1.96m

EN1176

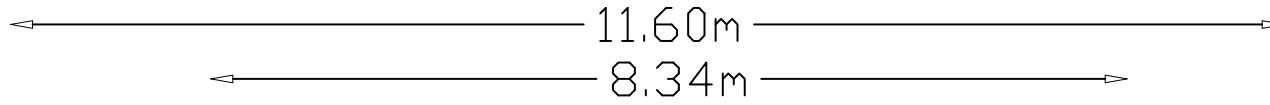

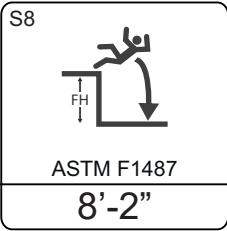

ASTM F1487

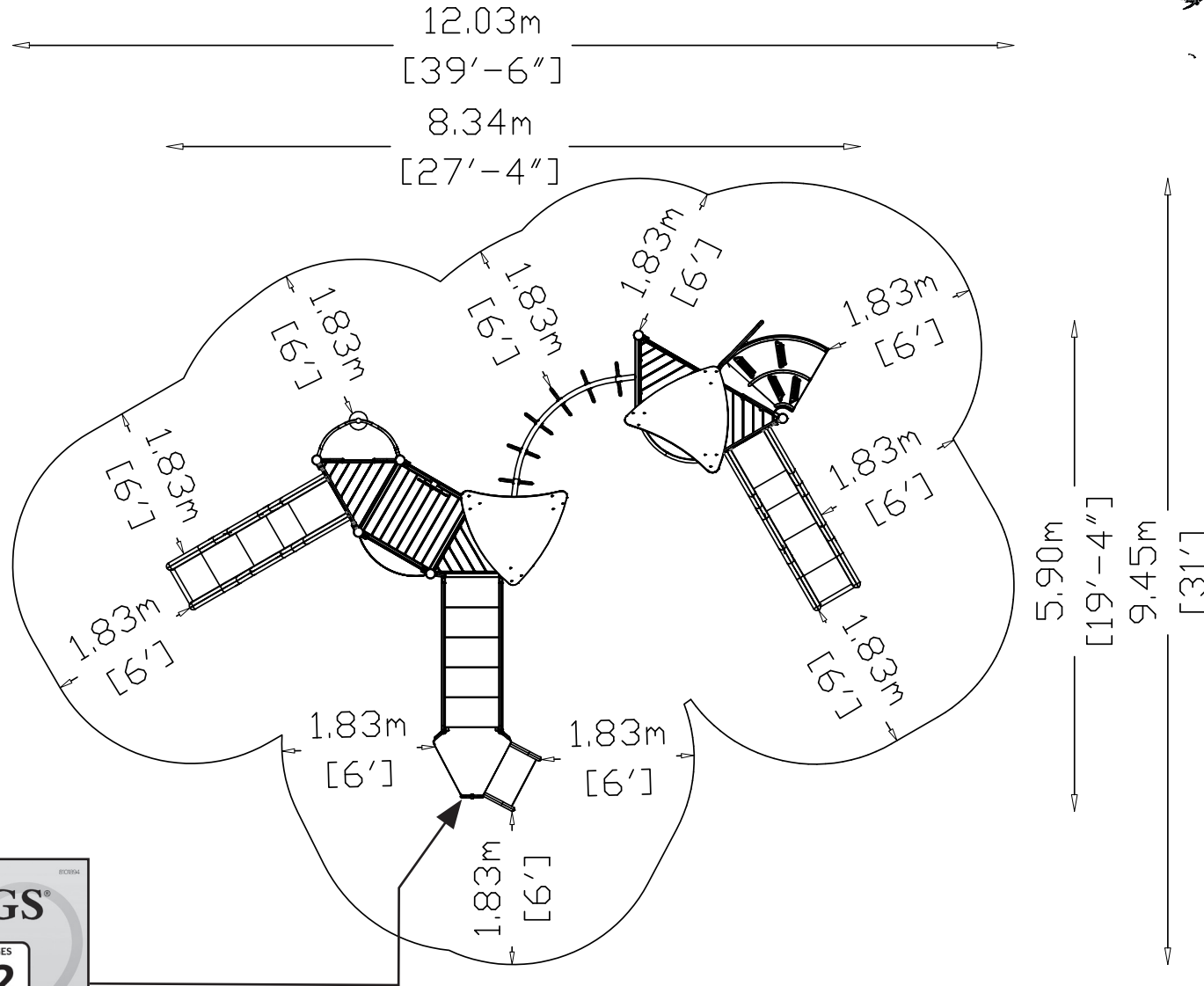

**INSTALL
101**

| | |
|--|--|
| <p>WARNING</p> <p>Playground equipment must not be used as a structure, support or padding until the manufacturer's instructions are read and followed. Do not use the equipment until it is installed correctly. Do not use the equipment until it is inspected by a qualified person.</p> <p>WARNING</p> <p>Children are capable of climbing and falling from the equipment. Do not allow children to play on the equipment until it is inspected by a qualified person. Do not allow children to play on the equipment until it is inspected by a qualified person.</p> <p>WARNING</p> <p>All playground equipment and rubber surfacing must be inspected regularly to ensure that it is safe for use. Check for hot surfaces before allowing children to play. Children should wear appropriate shoes at all times.</p> <p>WARNING</p> <p>Playground equipment is not to be used as a structure, support or padding until the manufacturer's instructions are read and followed. Do not use the equipment until it is inspected by a qualified person.</p> | <p>play smart! rules</p> <ul style="list-style-type: none"> ✓ Do not play on broken or damaged equipment. Report it. ✓ Do not play without adequate safety supervision. ✓ Do not play on or near equipment if the labels, notices or drawings should be kept with the equipment. ✓ Do not play on or near playground equipment and its structure until it is inspected. ✓ Watch your head! Do not run, slide, trip, climb, swing, or jump. ✓ Do not play on swings or any equipment if the seats or on top of metal through holes. ✓ Do not slide on metal surfaces or slides. ✓ Adults - do not slide with a child on your lap. It can injure your child's head. ✓ Before letting go of overhead bars, hand grips and hand holds, a child will slide straight down with both feet. ✓ Before sliding down, do not jump or slide sideways. Do not touch other children while playing and be careful! |
|--|--|



HAGS[®]

FOR KIDS AGES
5-12
YEARS

ADULT SUPERVISION RECOMMENDED
www.hags.com

S9

CSA Z 614
2.48m
[8'-2"]

CSA Z614

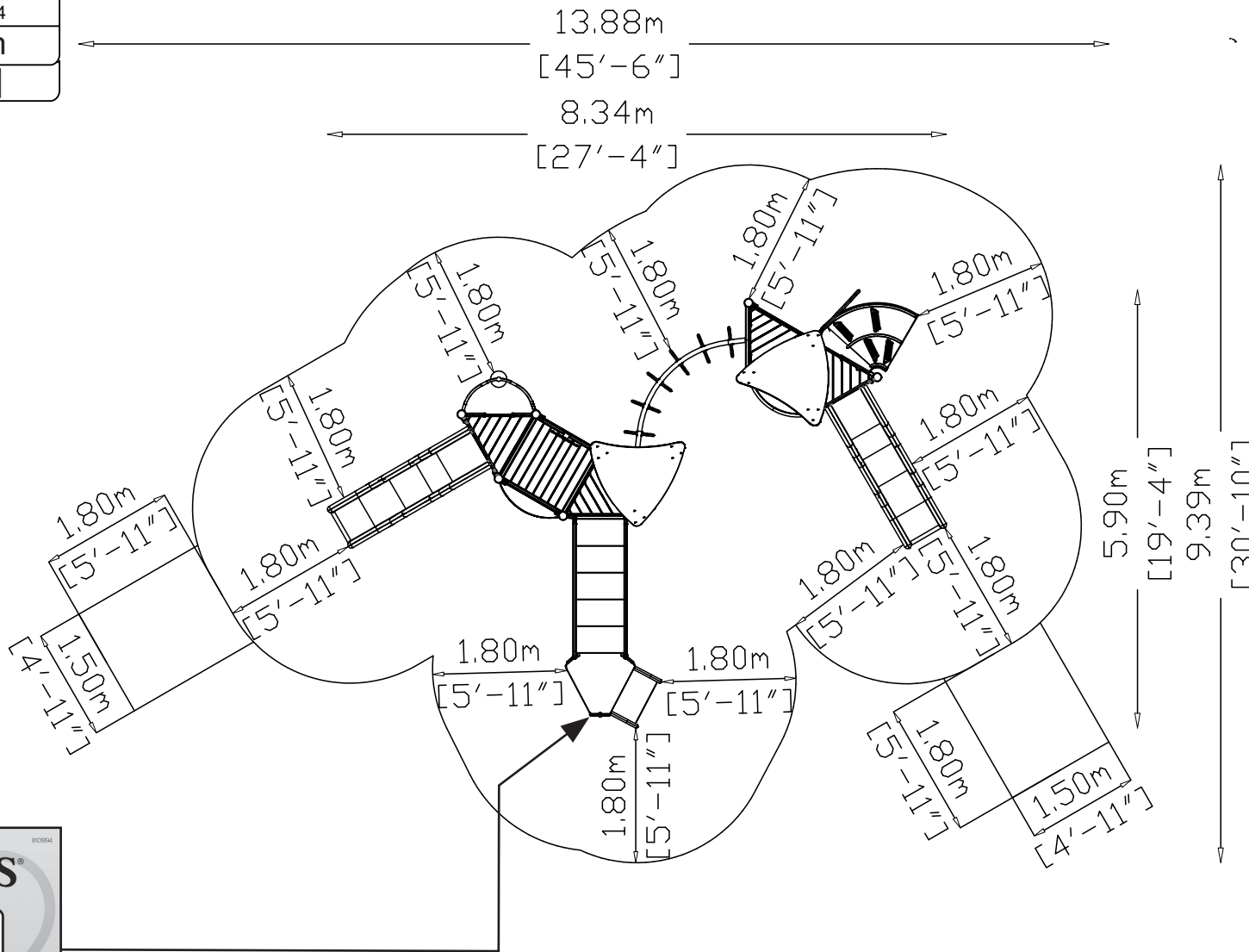

INSTALL 101

| | | |
|---|--|---|
| <p>WARNING</p> <p>Playground equipment must not be used as an obstacle, support or padding, and may require special steps or adult help. Check for the proper use of equipment. It is not to be used for anything other than its intended purpose.</p> | <p>WARNING</p> <p>Children are required to use the correct technique on slides and other playground equipment. Before allowing children to play, verify that the equipment is properly installed and that the equipment is in good condition. Check for hot surfaces before allowing children to play. Children should wear appropriate shoes at all times.</p> | <p>play smart! rules</p> <ul style="list-style-type: none"> Do not play on broken or damaged equipment. Report it. Do not play without adequate safety supervision. Do not play on or near equipment if the labels, notices or drawings should be seen only on equipment. Do not play on or near playground equipment and its structure if it is damaged. Watch your head! Do not run. Do not swing, climb, stare, or peer. Do not play on swings or on playground equipment if the structure is not safe. Do not play on trees or on trees of wood through trees. Do not drink or eat, eat, or use a phone, or on trees of wood through trees. Do not play on or near equipment if it is damaged. Adults - do not slide with a child on your back. It can injure your child's back. Before letting go of overhead bars, hand grips with hand your hands a little and slide straight down with both feet. Do not swing down with the feet. Do not play on or near equipment if it is damaged. Do not play on or near equipment if it is damaged. |
|---|--|---|



HAGS®

FOR KIDS AGES
5-12
YEARS

ADULT SUPERVISION RECOMMENDED
www.hags.com

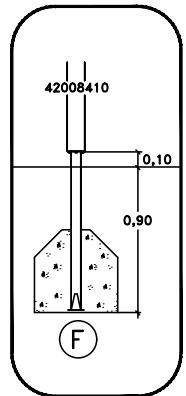
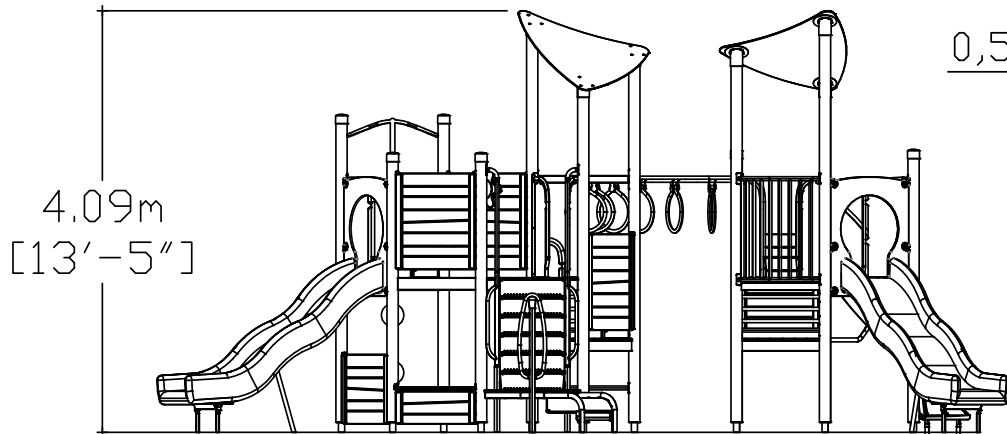
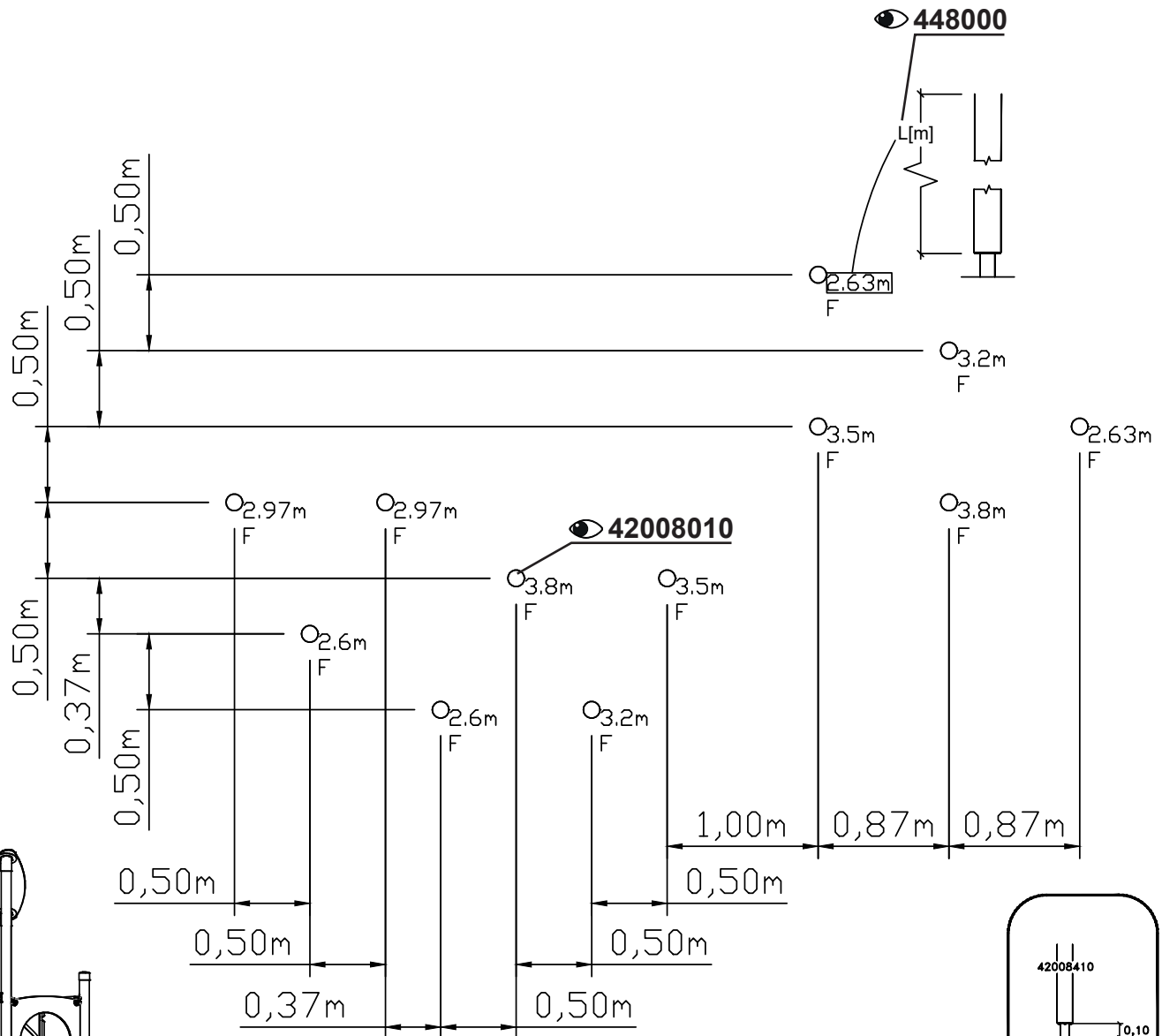
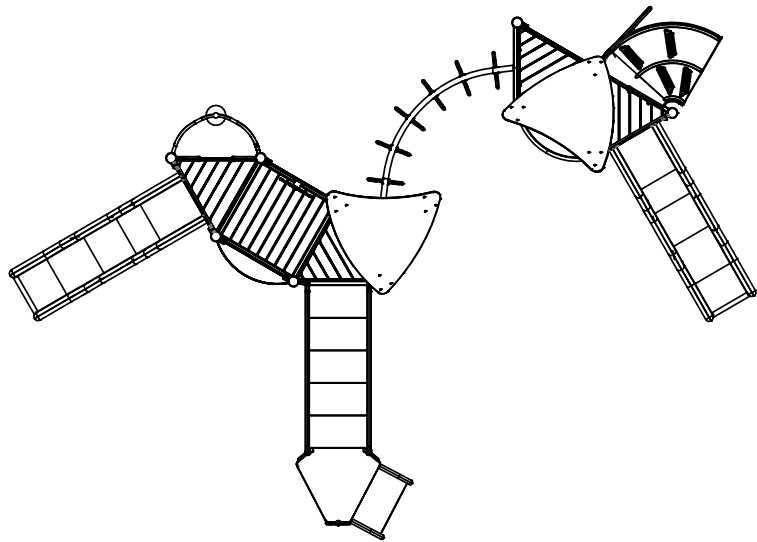

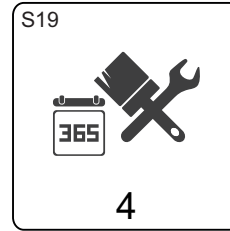
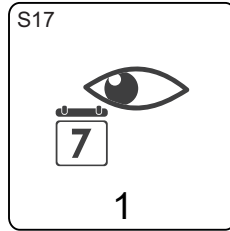
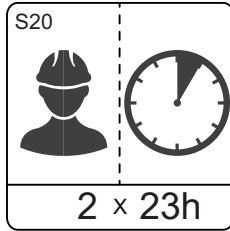
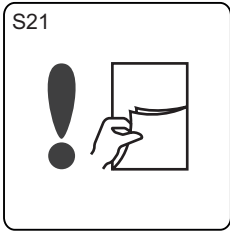

Install 101

260329

420960

420995

426162

426200

448000

42008010

42071503

42275323

42475323

MA420U78026

MA422U70010

MA422U77151

MA424U70010

MA424U77151

MA426121

MASW103874

MASW34156

MASW35156

MASW35330

MASW37573

MASW38904

MASW41284

MASW85869

 **42008010**

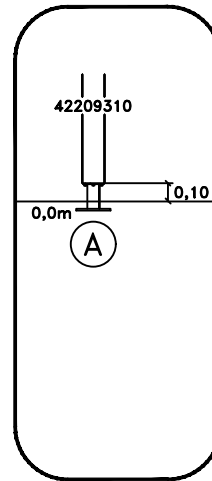

Above Ground

OM

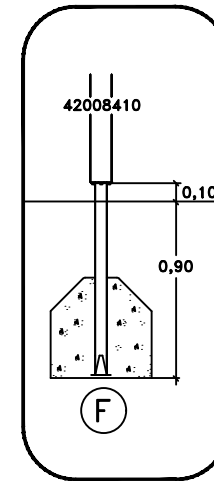

Cast Loose Fill

BM

8102031

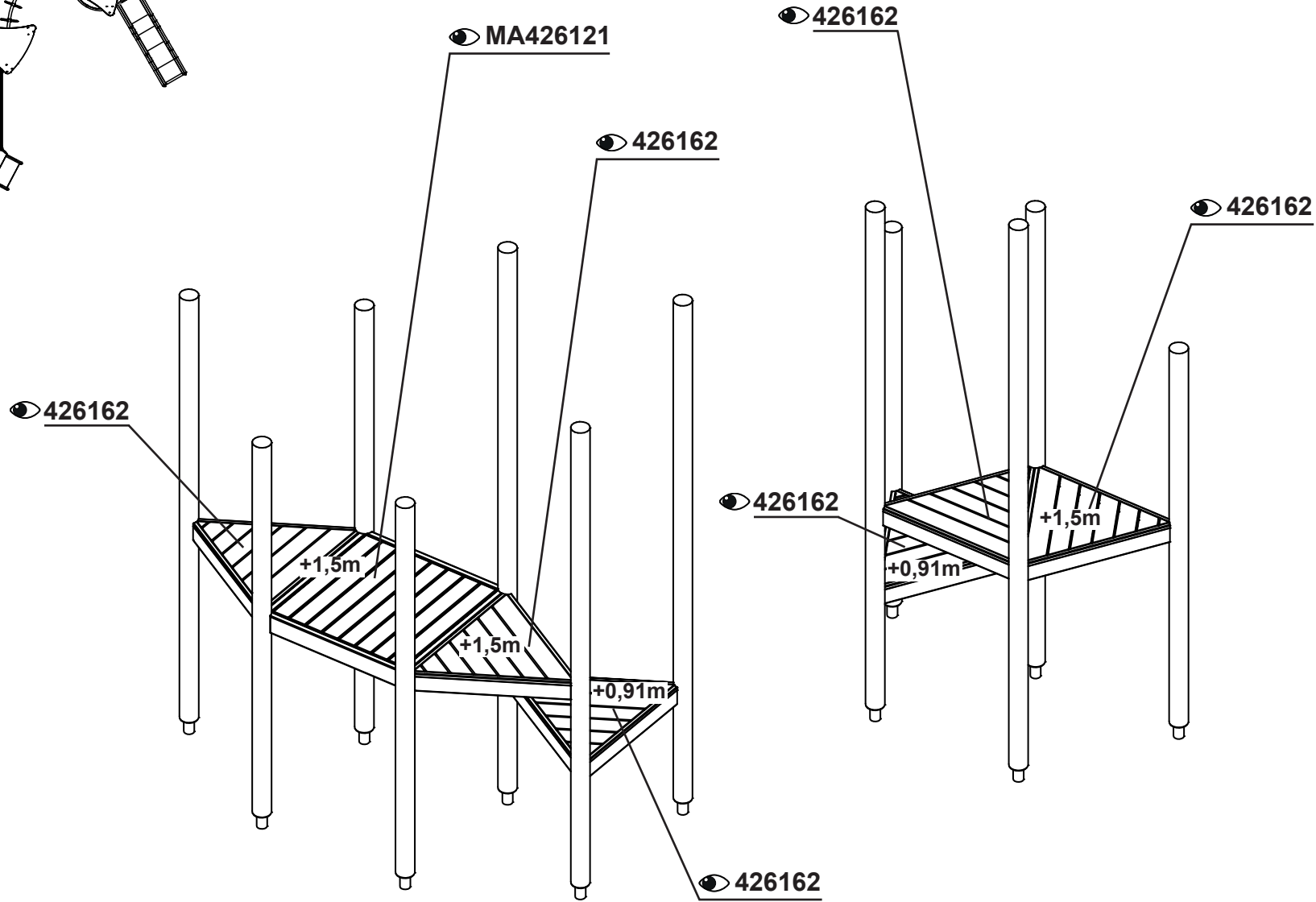
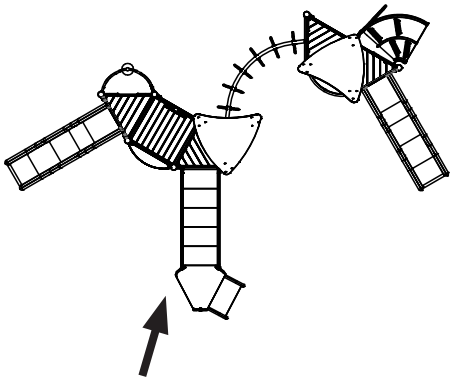

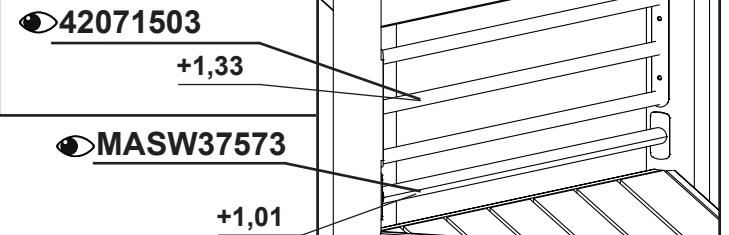
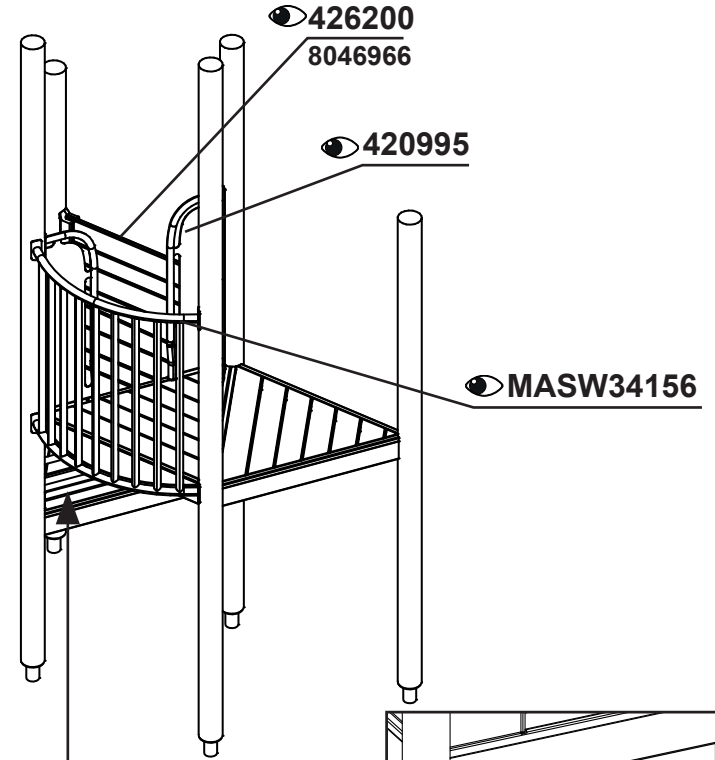
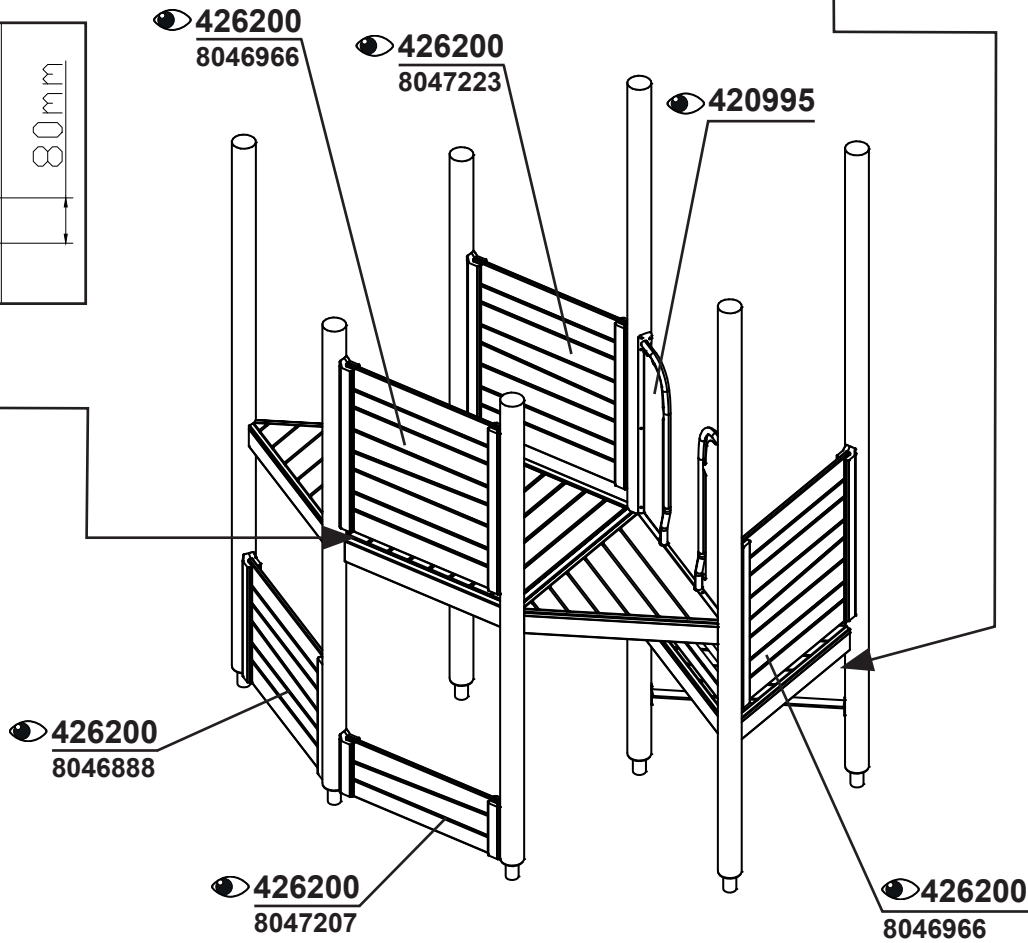
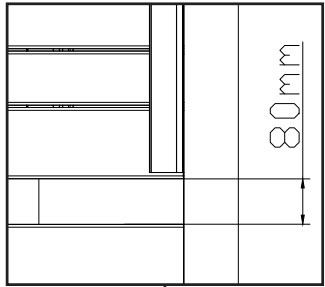
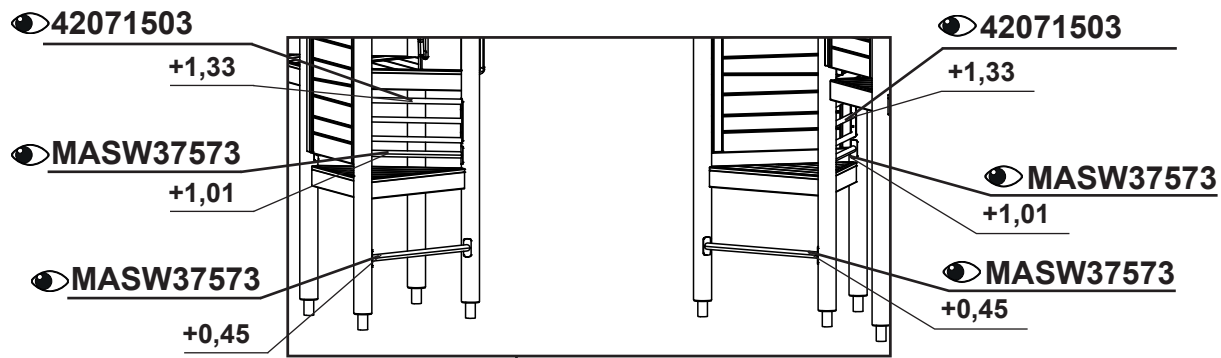
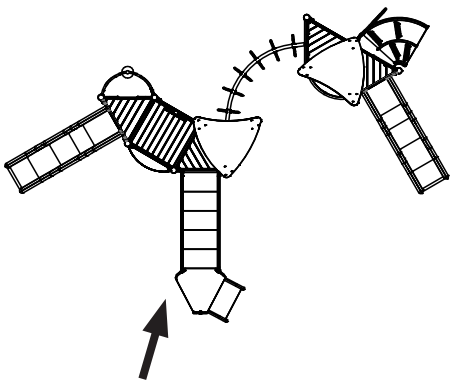

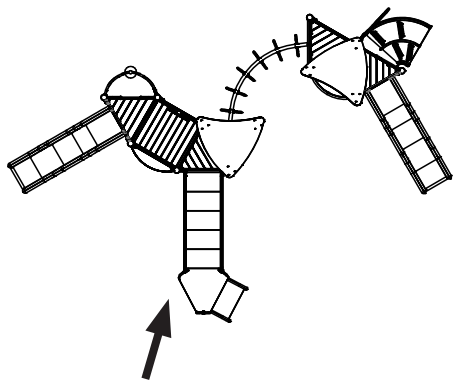

● MA424U77151 [BM]

● MA422U77151 [OM]

● MASW35156

+1,96m

● MA420U78026

● 420960

● MASW35330

● MA424U70010 [BM]

● MA422U70010 [OM]

● 42475323 [BM]

● 42275323 [OM]

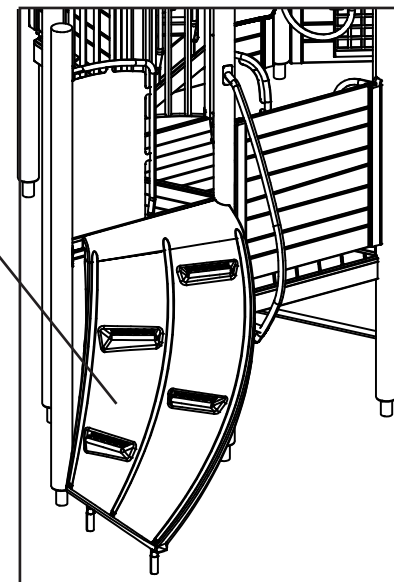
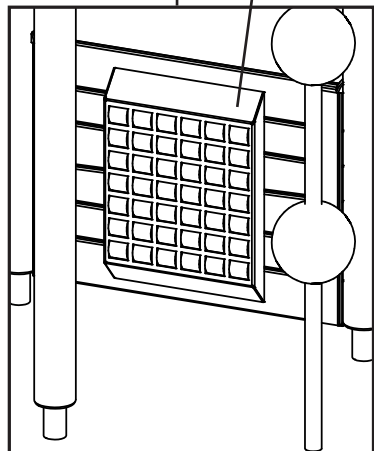

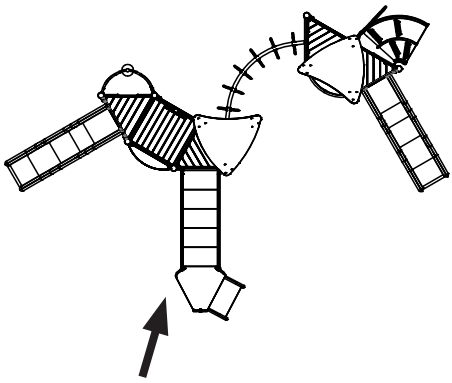

MASW38904

MASW38904

MASW41284

x6

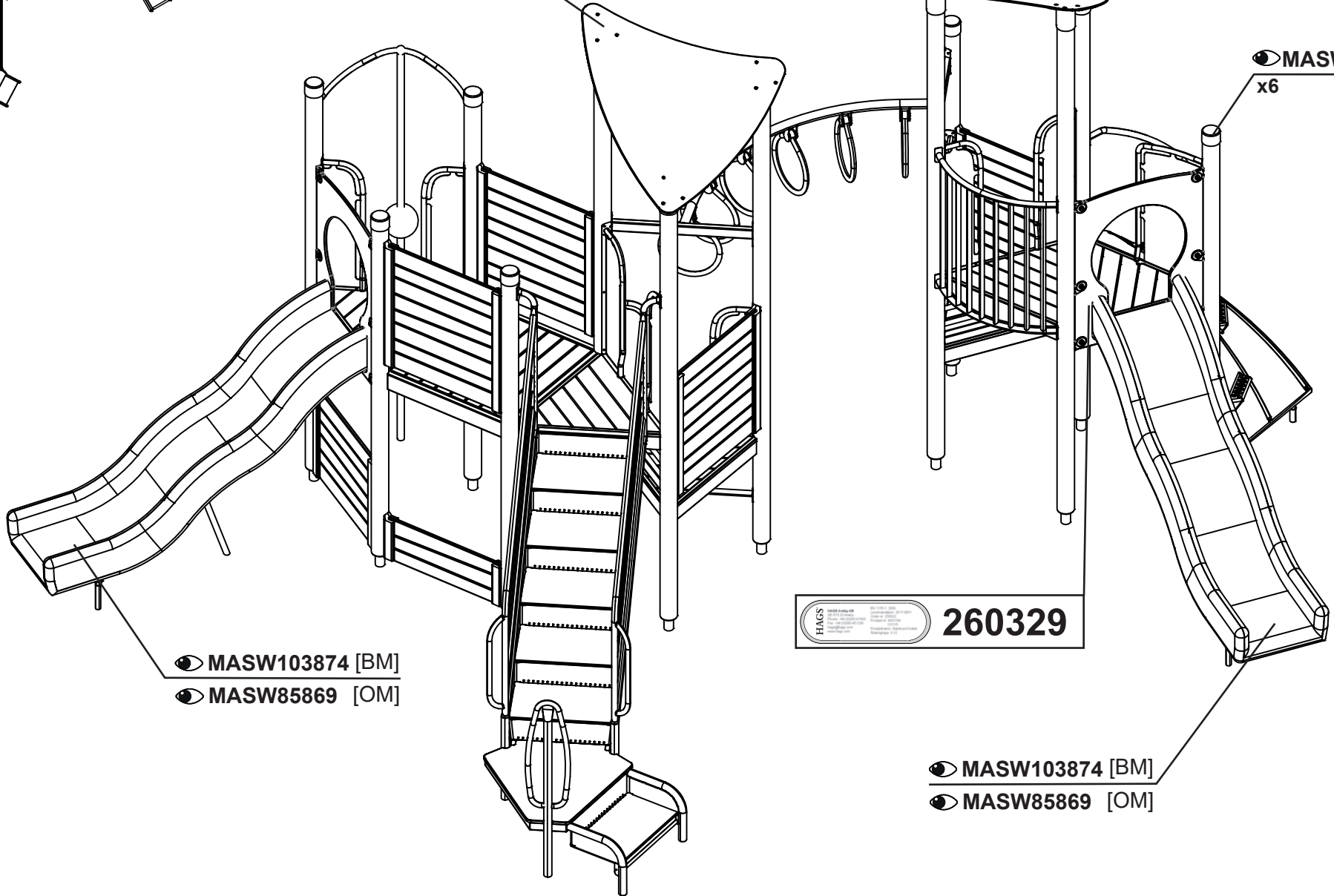

MASW103874 [BM]

MASW85869 [OM]

HAGS 260329

MASW103874 [BM]

MASW85869 [OM]